

## Rohrbogen 45° mit Muffen

Massbild

Material

Betriebsdruck

1031872

PPs

+/- 1500 Pa, 40°C

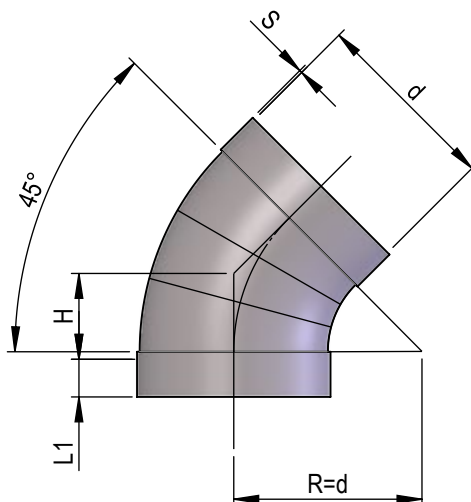

NG	H	L1	s	Art.-Nr.
50	30	25	3	32806
63	32	25	3	15150
75	35	35	3	12367
90	40	35	3	12368
110	55	40	3	15151
125	60	40	3	12355
140	70	40	3	12356
160	75	40	3	12357
180	85	50	3	12358
200	95	50	3	12359
225	105	50	3.5	12360
250	115	50	3.5	12361
280	125	50	4	12362
315	140	50	5	12363
355	160	50	5	12364
400	175	60	6	12365
450	200	60	6	15152
500	215	60	6	15153