

Ventilation pipe, moulded parts round

Saddle pipe 90° with sockets

Dimension drawing
Material
Operating pressure

1032134
PPs
+/- 1500 Pa, 40°C

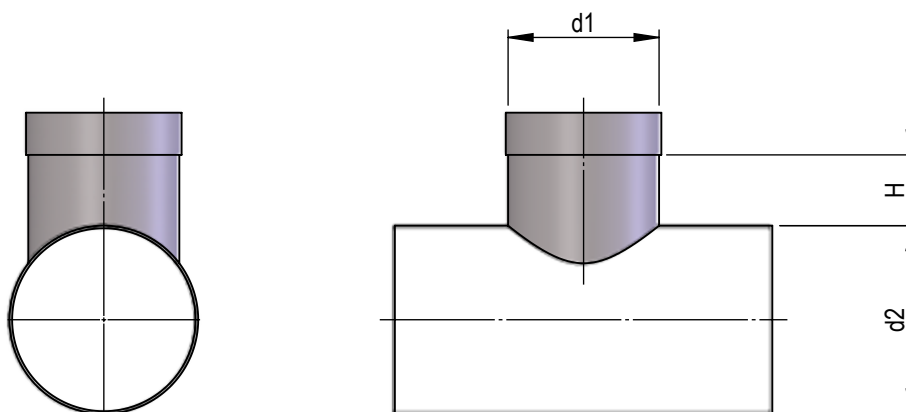

NG1	NG2	H	Item No.
50	≤50	100	39720
63	≤63	100	39721
75	≤75	100	39722
90	≤90	100	39723
110	≤110	100	39724
125	≤125	100	39725
140	≤140	100	39726
160	≤160	100	39727
180	≤180	100	39728
200	≤200	100	39729
225	≤225	100	39730
250	≤250	100	39731
280	≤280	100	39732
315	≤315	100	39733
355	≤355	100	39734
400	≤400	100	39735
450	≤450	100	39736
500	≤500	100	39737
560	≤560	100	39738
630	≤630	100	39739
710	≤710	100	39740
800	≤800	100	39741
900	≤900	100	39742
1000	≤1000	100	39743
1120	≤1120	100	39744
1250	≤1250	100	39745

Edition 2023 • Subject to alteration • Copyright by COLASIT AG Spiez

COLASIT AG

Plastic construction • Faulenbachweg 63 • CH-3700 Spiez
Phone +41 (0)33 655 61 61 • ventilations@colasit.com

www.colasit.com

Competence in plastics. Worldwide.

