

Ventilation pipe, moulded parts round

Reduction symmetrical with sockets

Dimension drawing
Material
Operating pressure

1025018
PPs
+/- 1500 Pa, 40°C

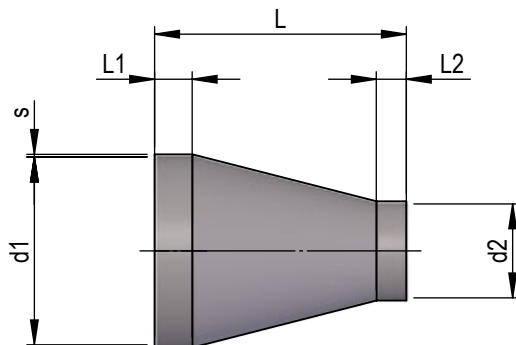

d1 - d2	L	L1	L2	s	Item No.
63-50	80	35	35	3	38770
75-50	115	35	35	3	38771
75-63	95	35	35	3	38772
90-50	145	35	35	3	38678
90-63	125	35	35	3	38679
90-75	110	35	35	3	15226
110-50	170	40	35	3	39625
110-63	165	40	35	3	38717
110-75	170	40	35	3	15227
110-90	125	40	35	3	15228
125-50	215	40	35	3	39626
125-63	195	40	35	3	39627
125-75	185	40	35	3	38680
125-90	155	40	35	3	38681
125-110	115	40	40	3	38682
140-50	240	40	35	3	39628
140-63	235	40	35	3	39629
140-75	210	40	35	3	39630
140-90	185	40	35	3	38683
140-110	150	40	40	3	38684
140-125	120	40	40	3	38685
160-50	275	40	35	3.5	39631
160-63	260	40	35	3.5	39632
160-75	260	40	35	3.5	39633
160-90	220	40	35	3.5	39634
160-110	185	40	35	3.5	15229
160-125	160	40	40	3.5	15230

Edition 2025 • Subject to alteration • Copyright by COLASIT AG Spiez

COLASIT AG

Plastic construction • Faulenbachweg 63 • CH-3700 Spiez
Phone +41 (0)33 655 61 61 • ventilations@colasit.com

www.colasit.com

Competence in plastics. Worldwide.



Ventilation pipe, moulded parts round

Reduction symmetrical with sockets

Dimension drawing 1025018
 Material PPs
 Operating pressure ventilation pipe +/- 1500 Pa, 40°C

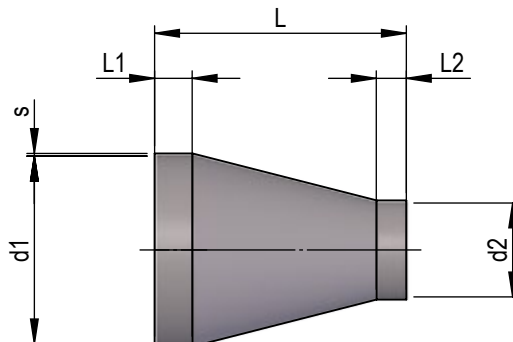

d1 - d2	L	L1	L2	s	Item No.
180-50	330	50	35	3.5	38453
180-63	310	50	35	3.5	39635
180-75	295	50	35	3.5	39636
180-90	270	50	35	3.5	39637
180-110	235	50	40	3.5	39638
180-125	210	50	40	3.5	38687
180-140	180	50	40	3.5	38688
180-160	140	50	40	3.5	38689
200-50	380	50	35	3	39639
200-63	345	50	25	3	39640
200-75	330	50	35	3	39641
200-90	305	50	35	3	39642
200-110	300	50	40	3	39643
200-125	245	50	40	3	39644
200-140	215	50	40	3	38690
200-160	195	50	50	3	15231
200-180	155	50	50	3	15233
225-50	425	50	35	3	39645
225-63	390	50	25	3	*
225-75	380	50	35	3	*
225-90	350	50	35	3	*
225-110	320	50	40	3	*
225-125	290	50	40	3	*
225-140	260	50	40	3	*
225-160	225	50	40	3	38691
225-180	200	50	50	3	38692
225-200	160	50	35	3	38693

Edition 2025 • Subject to alteration • Copyright by COLASIT AG Spiez

COLASIT AG

Plastic construction • Faulenbachweg 63 • CH-3700 Spiez
 Phone +41 (0)33 655 61 61 • ventilations@colasit.com

www.colasit.com

Competence in plastics. Worldwide.



Ventilation pipe, moulded parts round

Reduction symmetrical with sockets

Dimension drawing 1025018
 Material PPs
 Operating pressure ventilation pipe +/- 1500 Pa, 40°C

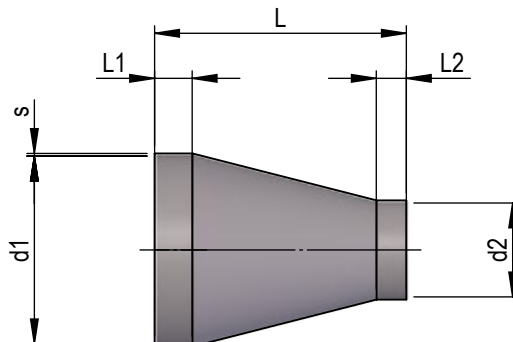

d1 - d2	L	L1	L2	s	Item No.
180-50	330	50	35	3.5	38453
180-63	310	50	35	3.5	39635
180-75	295	50	35	3.5	39636
180-90	270	50	35	3.5	39637
180-110	235	50	40	3.5	39638
180-125	210	50	40	3.5	38687
180-140	180	50	40	3.5	38688
180-160	140	50	40	3.5	38689
200-50	380	50	35	3	39639
200-63	345	50	25	3	39640
200-75	330	50	35	3	39641
200-90	305	50	35	3	39642
200-110	300	50	40	3	39643
200-125	245	50	40	3	39644
200-140	215	50	40	3	38690
200-160	195	50	50	3	15231
200-180	155	50	50	3	15233
225-50	425	50	35	3	39645
225-63	390	50	25	3	*
225-75	380	50	35	3	*
225-90	350	50	35	3	*
225-110	320	50	40	3	*
225-125	290	50	40	3	*
225-140	260	50	40	3	*
225-160	225	50	40	3	38691
225-180	200	50	50	3	38692
225-200	160	50	35	3	38693

Edition 2025 • Subject to alteration • Copyright by COLASIT AG Spiez

COLASIT AG

Plastic construction • Faulenbachweg 63 • CH-3700 Spiez
 Phone +41 (0)33 655 61 61 • ventilations@colasit.com

www.colasit.com

Competence in plastics. Worldwide.



Ventilation pipe, moulded parts round

Reduction symmetrical with sockets

Dimension drawing 1025018
 Material PPs
 Operating pressure ventilation pipe +/- 1500 Pa, 40°C

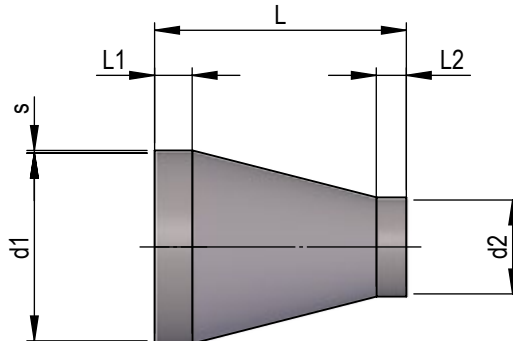

d1 - d2	L	L1	L2	s	Item No.
250-90	400	50	35	3.5	39646
250-110	365	50	40	3.5	39647
250-125	335	50	40	3.5	39648
250-140	310	50	40	3.5	*
250-160	285	50	40	3	15232
250-180	245	50	50	3	15234
250-200	200	50	50	3	15238
250-225	160	50	50	3	15239
280-110	425	50	40	3.5	39649
280-125	395	50	40	3.5	*
280-140	365	50	40	3.5	*
280-160	340	50	50	3.5	*
280-180	305	50	50	3.5	*
280-200	265	50	50	3.5	38694
280-225	220	50	50	3.5	15240
280-250	175	50	50	3.5	38695
315-110	470	50	40	4	39650
315-125	460	50	40	4	*
315-140	435	50	40	4	*
315-160	395	50	40	4	39651
315-180	360	50	40	4	39652
315-200	330	50	50	4	38824
315-225	285	50	50	4.5	38696
315-250	240	50	50	4.5	15241
315-280	195	50	50	4.5	15242
355-160	485	50	50	5	39652
355-180	445	50	50	5	*
355-200	410	50	50	5	*
355-225	360	50	50	5	*

Edition 2025 • Subject to alteration • Copyright by COLASIT AG Spiez

COLASIT AG
 Plastic construction • Faulenbachweg 63 • CH-3700 Spiez
 Phone +41 (0)33 655 61 61 • ventilations@colasit.com
www.colasit.com

Competence in plastics. Worldwide.



Ventilation pipe, moulded parts round

Reduction symmetrical with sockets

Dimension drawing 1025018
 Material PPs
 Operating pressure ventilation pipe +/- 1500 Pa, 40°C

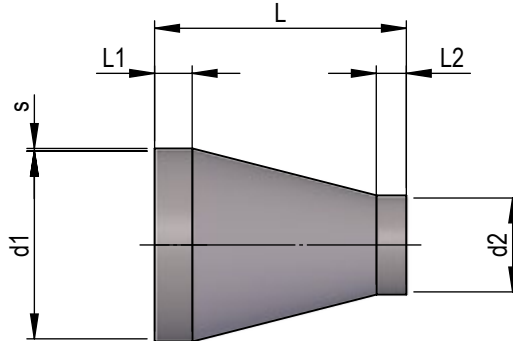

d1 - d2	L	L1	L2	s	Item No.
355-250	315	50	50	4.5	38697
355-280	255	50	50	5	38698
355-315	200	60	50	5	15243
400-160	580	60	50	5	39653
400-180	540	60	50	5	*
400-200	500	60	50	5	*
400-225	455	60	50	5	*
400-250	410	60	50	5	*
400-280	355	60	50	5	38699
400-315	390	60	50	5	15244
400-355	215	60	50	5	38700
450-200	600	60	50	6	39654
450-225	550	60	50	6	*
450-250	505	60	50	6	*
450-280	450	60	50	6	*
450-315	385	60	50	6	38701
450-355	310	60	50	6	38702
450-400	235	60	60	6	38703
500-200	680	50	50	6	39655
500-225	635	50	50	6	*
500-250	610	70	50	6	*
500-280	555	70	50	6	*
500-315	500	65	65	6	*
500-355	410	65	50	6	38704
500-400	335	70	55	6	38705
500-450	245	70	60	6	38706

Edition 2025 • Subject to alteration • Copyright by COLASIT AG Spiez

COLASIT AG
 Plastic construction • Faulenbachweg 63 • CH-3700 Spiez
 Phone +41 (0)33 655 61 61 • ventilations@colasit.com
www.colasit.com

Competence in plastics. Worldwide.

